

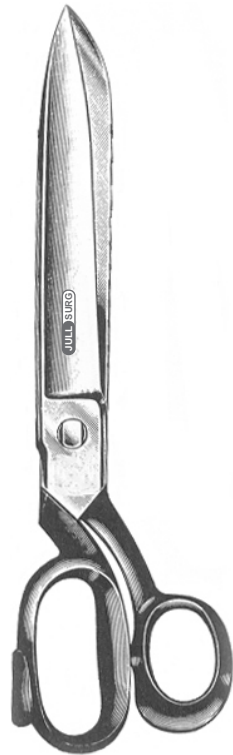

7132 5 1/2"
7133 7 1/2"



7136



7342



7343

LISTER BANDAGE CUTTING SCISSORS

7132 5 1/2"

7133 7 1/2"

7136 GAUGE CUTTING SCISSORS

7342 UMBILICAL CORD SCISSORS

7343 EPISIOTOMY SCISSORS

HYSTERECTOMY MAINGOTS FORCEPS

7159 Straight

7160 Curved

HEANYS HYSTERECTOMY FORCEPS

7161 St. Single Tooth

7162 Cvd. Single Tooth

7163 St. Double Tooth

7164 Cvd. Double Tooth

HYSTERECTOMY CLAMP DeBAKY

7166 Straight

7167 Curved



7159



7160

7161 Straight

7162 Curved

7163 Straight

7164 Curved



7166

7167

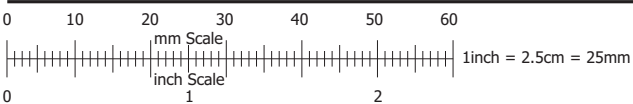



7173



7174 10"



7186 6"
7187 8"



7188 25mm x 6mm
7189 35mm x 15mm
7190 45mm x 20mm
7191 65mm x 25mm
7192 75mm x 25mm
7193 90mm x 25mm

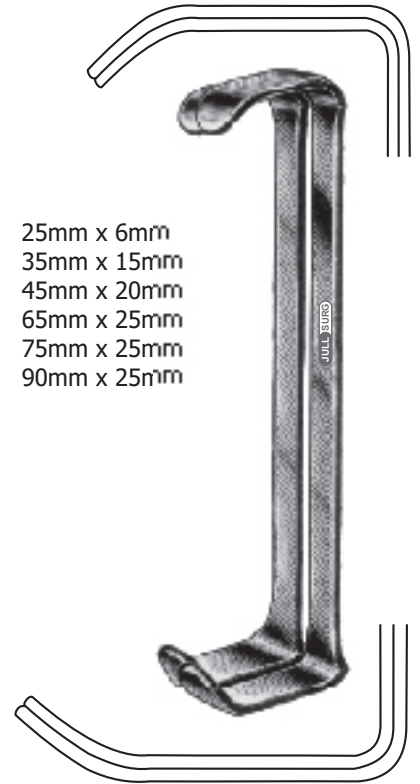

7194

7173 CHITAL JAR
7173 CHITAL FORCEPS
CZERNY RETRACTOR

7186 6"
7187 8"

LANGENBECK RETRACTOR

7188 25MM X 6MM
7189 35MM X 15MM
7190 45MM X 20MM
7191 65MM X 25MM
7192 75MM X 25MM
7193 90MM X 25MM

7194 LANES RETRACTOR
7195 ROUX RETRACTOR

SET OF 3

7196 LANDONS VAGINAL
RETRACTOR 25mmx 100mm.

7172 MAYO SAFETY PIN
INSTRUMENTS HOLDER

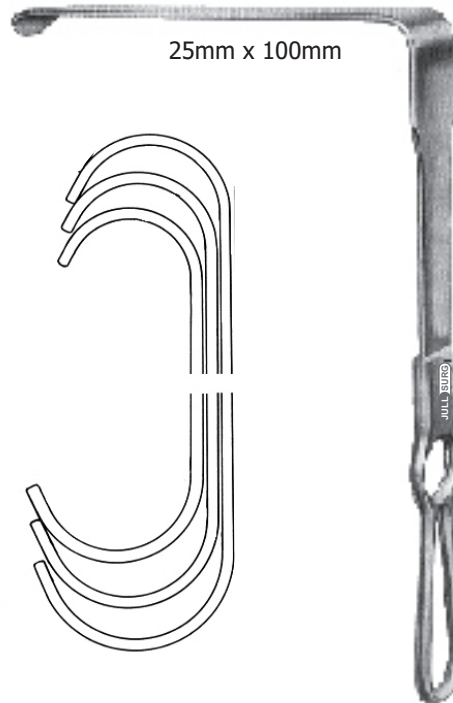

25mm x 100mm

7195

7196

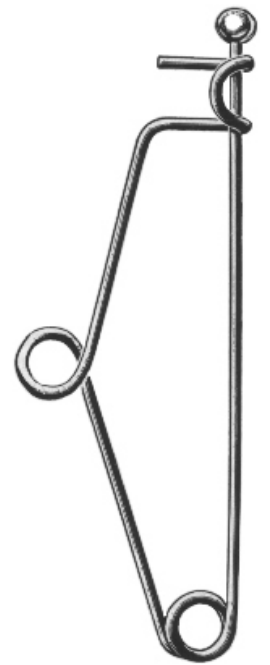

7172

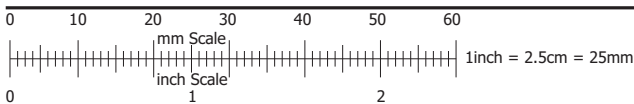



- 7199 1" x 12"
- 7200 1½" x 12"
- 7201 2" x 12"
- 7202 2½" x 12"



- 7210 1½"
- 7211 2"
- 7212 2½"
- 7213 3"



- 7214 1"
- 7215 1½"
- 7216 2"
- 7217 2½"
- 7218 3"
- 7219 3½"
- 7220 4"

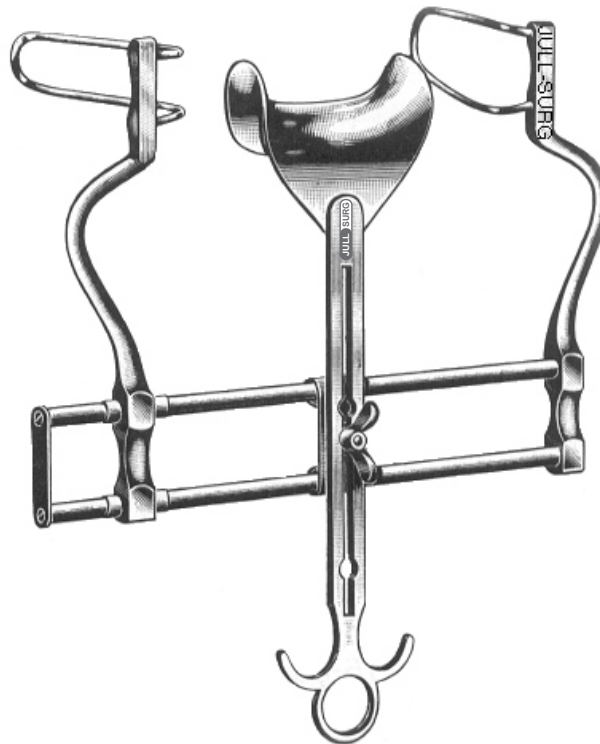

7230



7231

DEAVERS RETRACTOR

- 7199 1" x 12"
- 7200 1½" x 12"
- 7201 2" x 12"
- 7202 2½" x 12"

MORRIS RETRACTOR

- 7210 1½" 7211 2"
- 7212 2½" 7213 3"

DOYEN RETRACTOR

- 7214 1" 7215 1½"
- 7216 2" 7217 2½"
- 7218 3" 7219 3½"
- 7220 4"

7230 BALFOUR ABDOMINAL SELF RETAINING RETRACTOR

7231 POZZI ABDOMINAL SELF RETAINING RETRACTOR

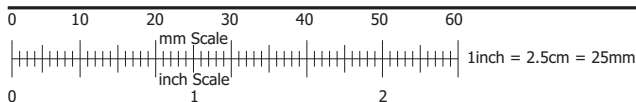

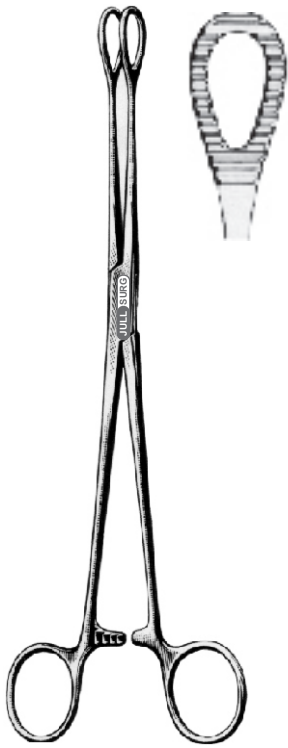

7292 8"
7293 10"



7294



7295



7296

SPONGE HOLDING FORCEPS

7292 8"
7293 10"

- 7294 UTERINE VULSELLUM FORCEPS
- 7295 UTERINE TENACULUM FORCEPS
- 7296 UTERINE ELEVATING FORCEPS
- 7297 UTERINE DRESSING FORCEPS
- 7298 OVEM FORCEPS STRAIGHT
- 7299 OVEM FORCEPS CURVED
- 7300 COLLIN UTERINE ELEVATING FORCEPS

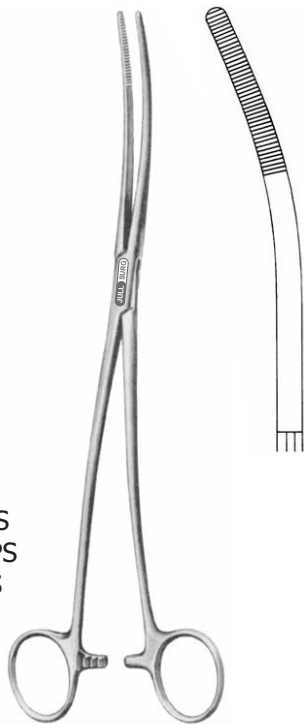

7297



7298



7299

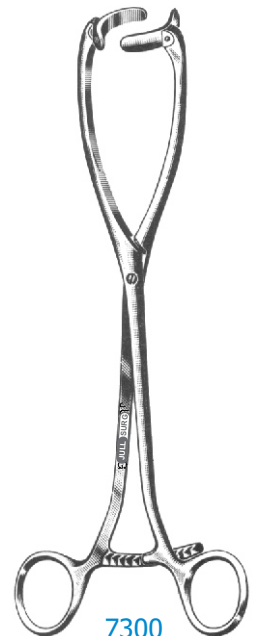

7300

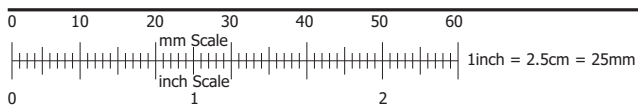

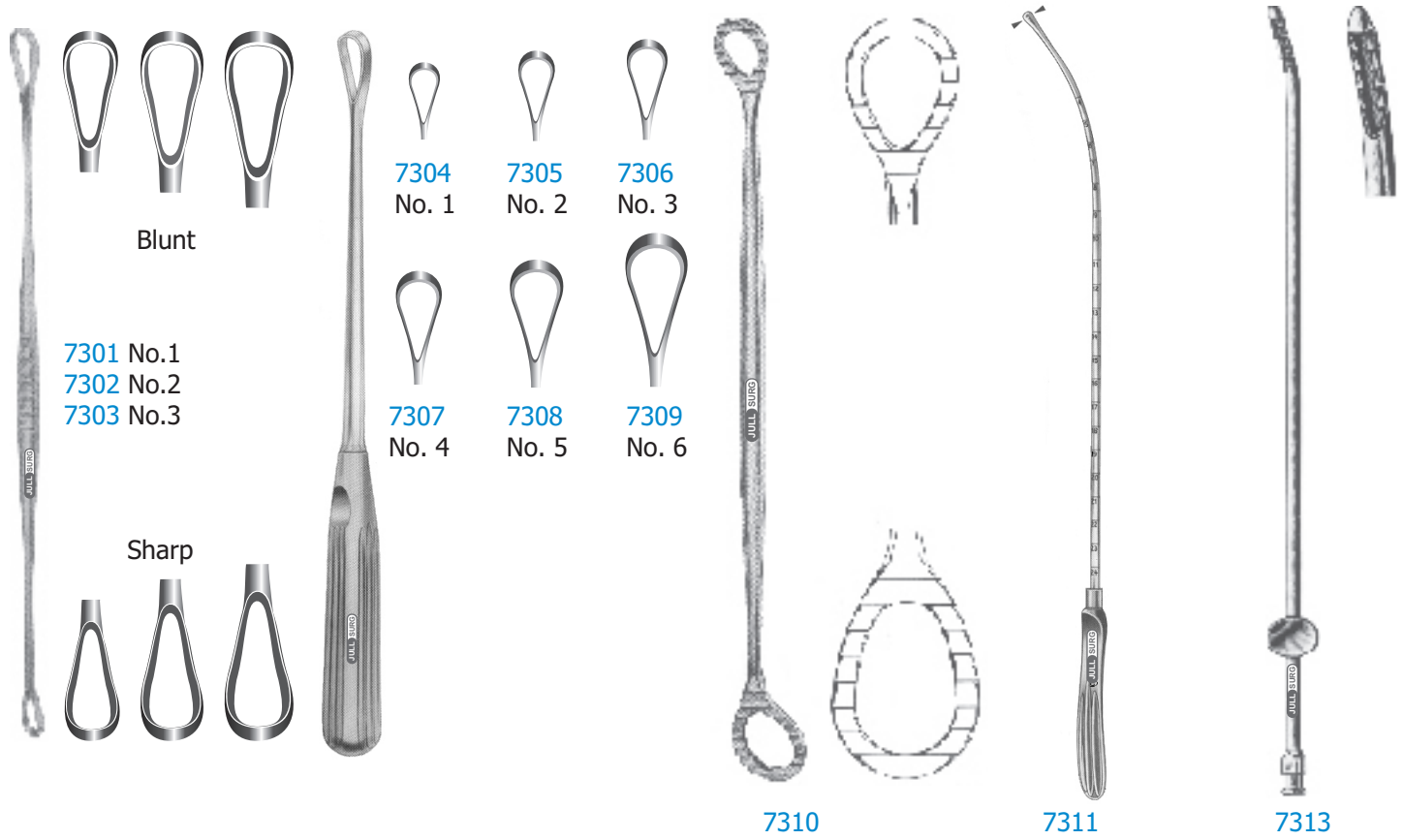

**UTERINE CURETTES
DOUBLE SHARP-BLUNT**

- 7301 No. 1
- 7302 No. 2
- 7303 No. 3

SIMS UTERINE CURETTES

- 7304 No. 1
- 7305 No. 2
- 7306 No. 3
- 7307 No. 4
- 7308 No. 5
- 7309 No. 6

- 7310 INTERIOR VAGINAL WALL RETRACTOR
- 7311 GRADUTED UTERINE SOUND
- 7313 ENDOMETRIAL BIOPSY CURETTE NOVAK

CUSCO VAGINAL SPECULUM

- 7314 Small
- 7315 Medium
- 7316 Large

CUSCO VAGINAL SPECULUM GRAVES

- 7317 Small
- 7318 Medium
- 7319 Large

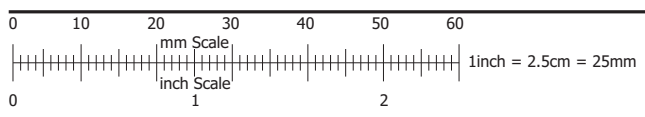
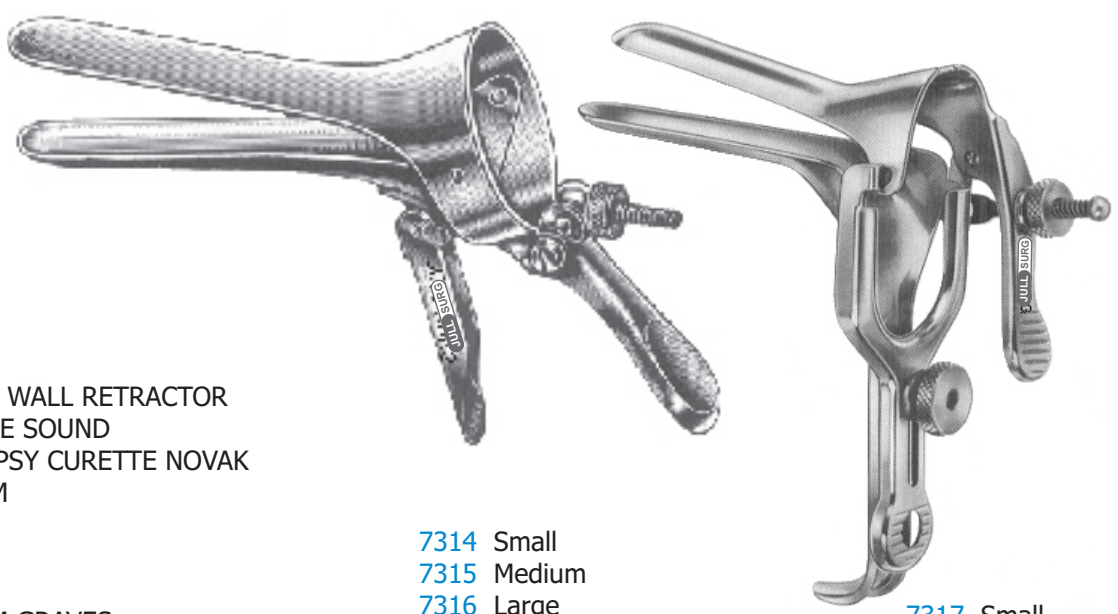

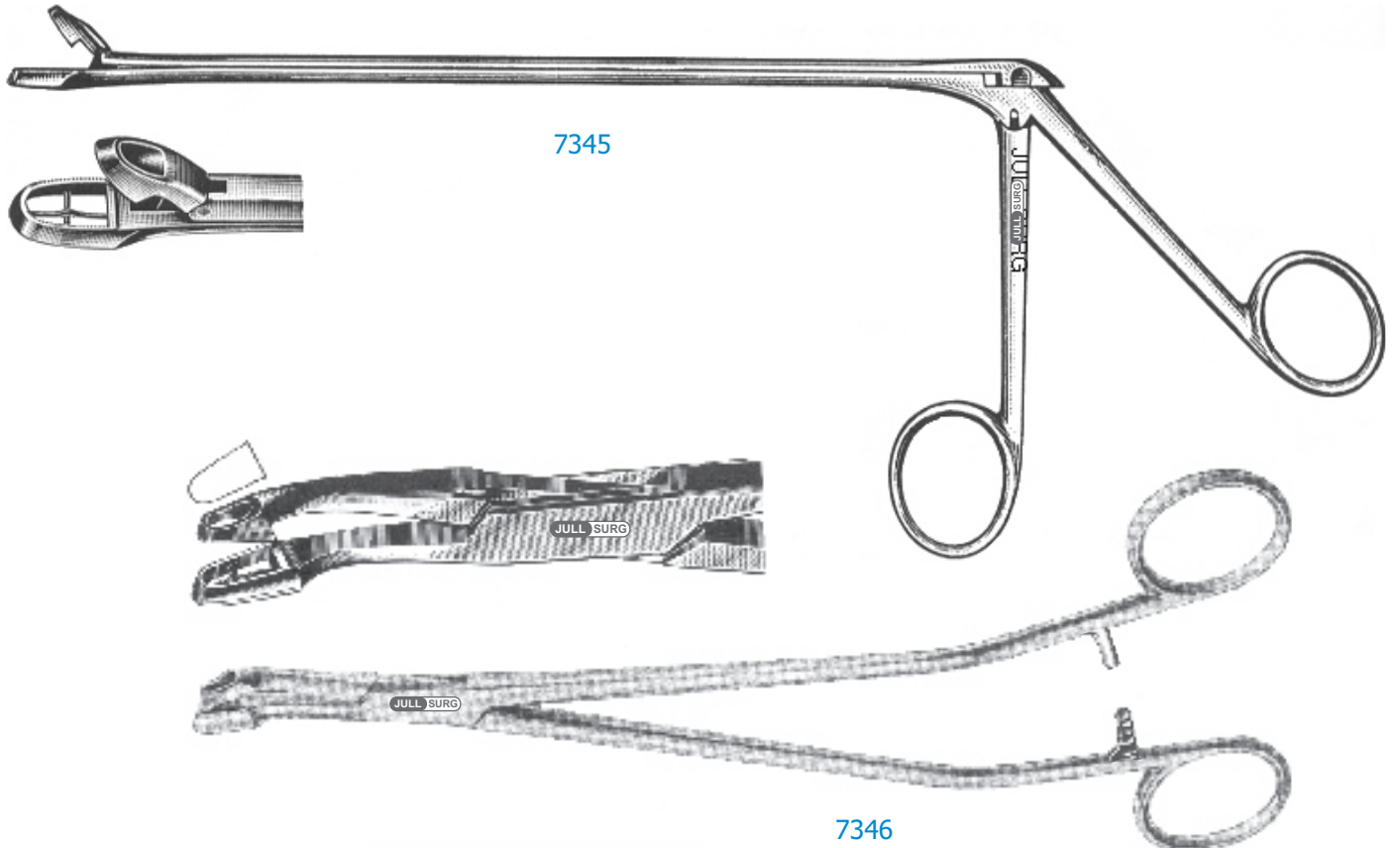

- 7345 BIOPSY PUNCH
- 7346 FORCEPS ALEXANDER
- 7346 CERVICAL BIOPSY PUNCH
- 7346 FORCEPS VAN DOREN
- G-11603 UTERINE MANUPLATER
- G-11604 UTERINE TENACULUM FORCEPS STRAIGHT
- G-11605 UTERINE TENACULUM FORCEPS CURVED

